

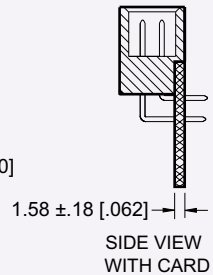

# DIN 41612

## Type B, B/2 Male Connectors

### Type B, 64 Positions

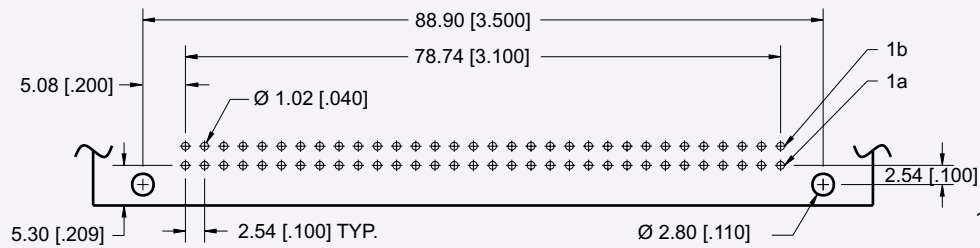
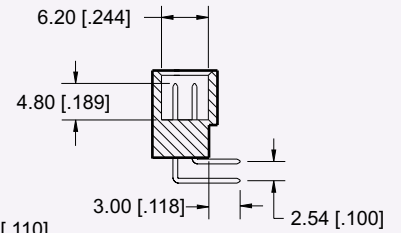
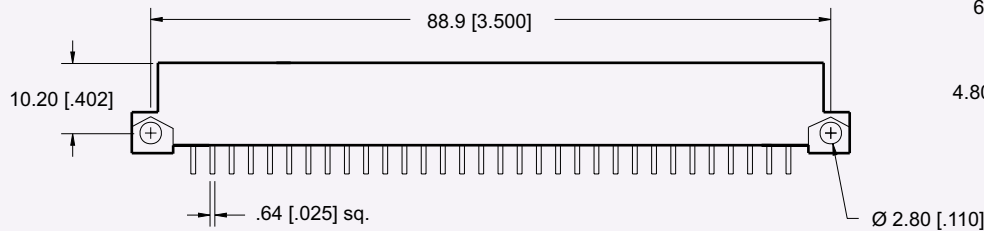
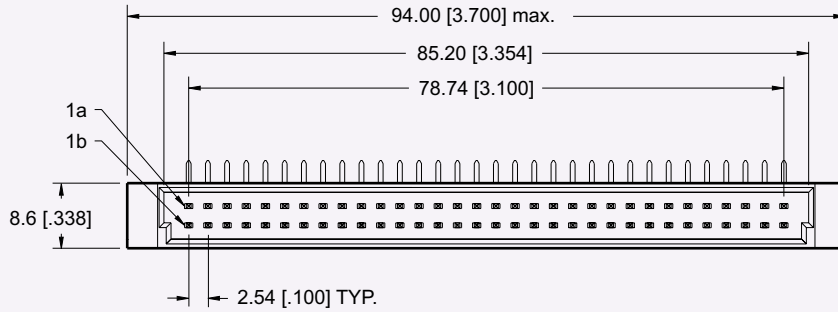

Recommended P. C. Board Layout

Dimensions are in mm [inches]

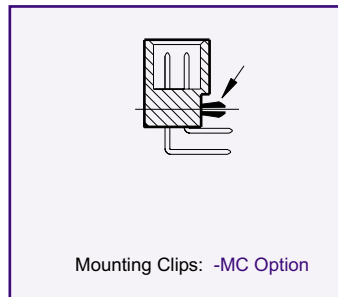
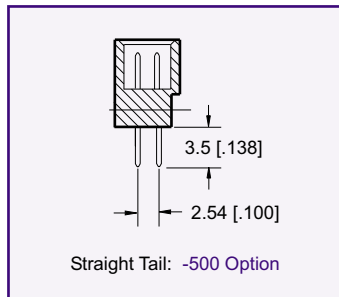

## Type B/2, 32 Positions

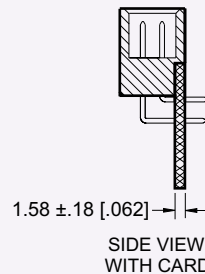
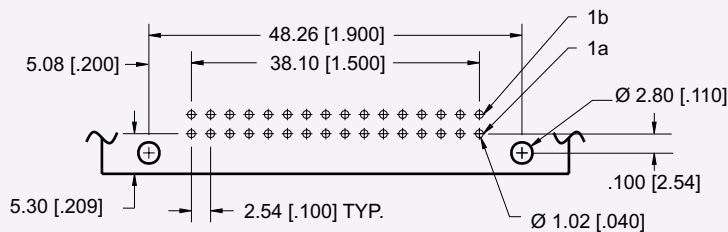
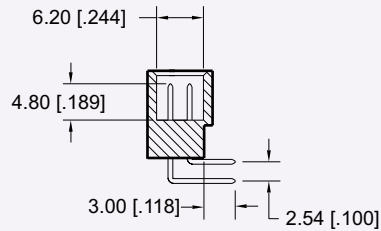
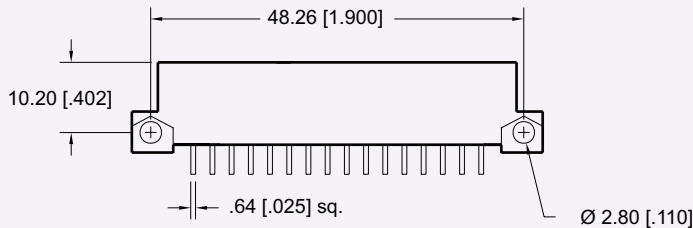
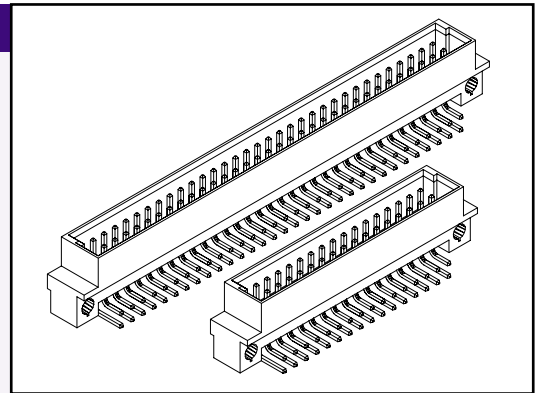
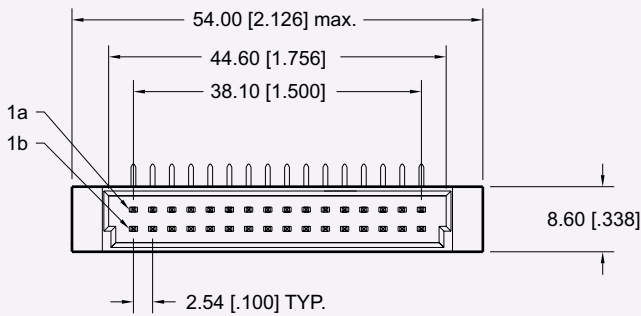

Recommended P. C. Board Layout

Dimensions are in mm [inches]

## PART NUMBERING

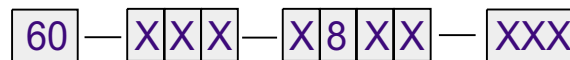

### SERIES CODE

DIN 41612 Type B, B/2 Male

### BODY STYLE

- 1 = B/2 (32 positions)
- 2 = B (64 positions)

### NO. OF CONTACTS

- 1 = 16
- 2 = 32
- 3 = 64

### CONTACT LOADING

- 1 = Row A and B fully populated
  - 2 = Row A fully populated, Row B not populated
  - 3 = Row B fully populated, Row A not populated
- Consult Factory for other Loading Options

- Blank = No Mounting Clip
- MC = Mounting Clip
- 500 = Straight Tail

### TAIL PLATING

- 1 = Tin Lead

### MATING AREA PLATING

- 1 = Class 1
- 2 = Class 2
- 3 = Class 3

### EMLB/LMEB CONTACTS

- 2 = Standard Pin Loading
- 1 = EMLB / LMEB Contacts Required (Consult Factory for EMLB / LMEB Contact Locations)

CONSULT FACTORY FOR CONNECTORS BUILT TO YOUR DESIGN