

# .100 [2.54] 3 ROW ELEVATED SOCKET



## Specifications

**Current Rating:** 3 Amps  
**Insulator Resistance:** 5000 Megohms min  
**Contact Resistance:** 20m ohms max  
**Dielectric Withstanding:** AC 1000V  
**Operating Temperature:** -40° ~± 105° C  
**Contact Material:** Phosphor Bronze  
**Insulator Material:** Polyester, UL 94V-0, PBT  
**Finish:** See Contact Plating



Recognized under the recognized component Program of Underwriters Laboratories, Inc.

Products specifications are subject to be changed without notice.

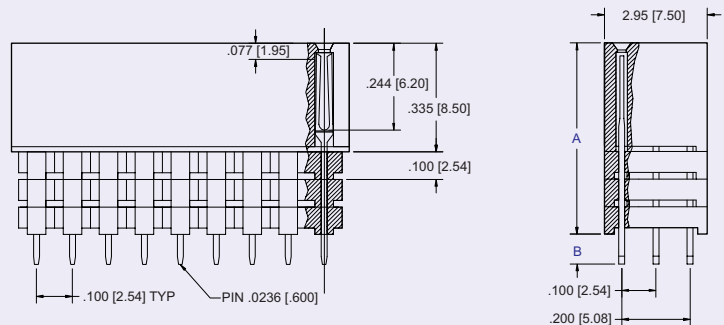
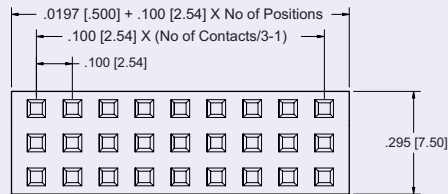

Recommended P.C.B Layout

Dimensions are in inches [mm]

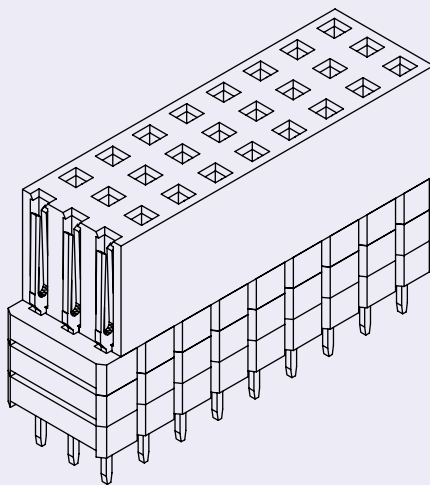

## PART NUMBERING



SERIES CODE

NO. OF CONTACTS

09 to 96

STACKING HEIGHT

A	B
01 = .435 [11.05]	.098 [2.50]
02 = .435 [11.05]	.289 [7.35]
03 = .535 [13.59]	.191 [4.85]
04 = .635 [16.13]	.091 [2.30]
05 = .435 [11.05]	.480 [12.2]
06 = .535 [13.59]	.380 [9.65]
07 = .635 [16.13]	.280 [7.10]
08 = .735 [18.67]	.181 [4.60]

CONTACT PLATING

**Lead Free & RoHS Compliant**

.000050" Nickel underplate

CONTACT

05 = Gold Flash

10 = 10µ" Gold

20 = 15µ" Gold

30 = 30µ" Gold

CONSULT FACTORY FOR CONNECTORS BUILT TO YOUR DESIGN