

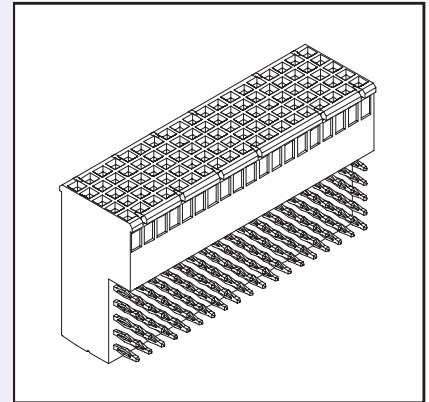

€-Z met™ 2mm HM Type B-19 Receptacle, Right Angle

The €-Z met™ Type B-19 connector provides 95 contacts. These connectors are available either with or without integrated upper ground return shields. Lower ground return shields may be ordered separately.

The Type B-19 connector is used in the J3 position on the Compact PCI® daughtercard. This connector is not designed to be used alone, but may be used together with either a Type A, C, L, M or N €-Z met™ connector.

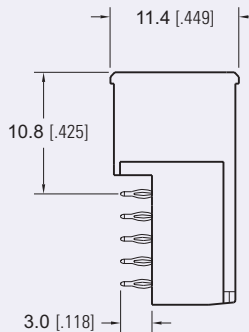
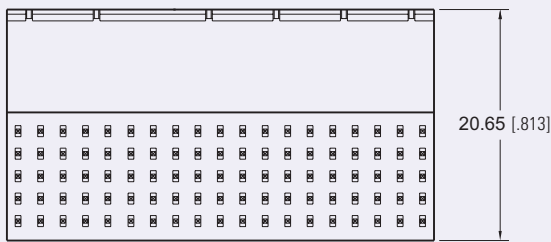
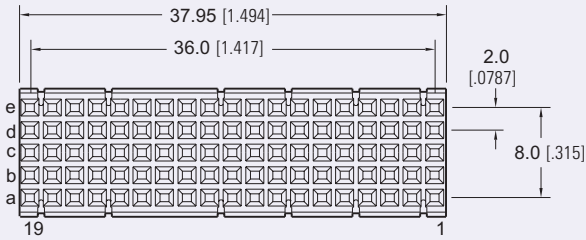

Dimensions are in mm [inch]

BOARD LAYOUT

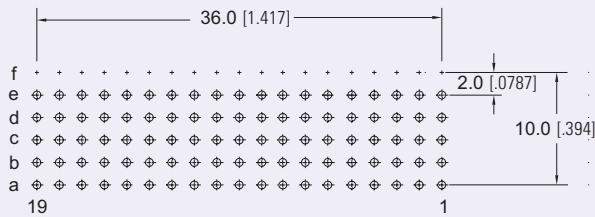

Lower Shield P/N 71-B19-01

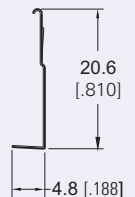
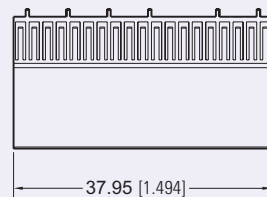
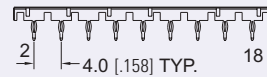

PART NUMBERING

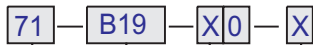

SERIES CODE
2mm Hard Metric Female

TYPE
B19

UPPER SHIELD
0 = Without Upper Shield
1 = With Upper Shield

CONTACT LOADING

- 1 = A, B, C, D, E
- 2 = A, B, C, D
- 3 = A, B, C
- 4 = A, D, E
- 5 = B, D

Upper Shield P/N 71-B19-10

